

ITEM NO.	QTY.	PART NO.	DESCRIPTION
1	1	3398	60-F11 EA FLIPPER
2	1	8929	EA FLIPPER HINGE ASSEMBLY-LEFT
3	1	8930	EA FLIPPER HINGE ASSEMBLY-RIGHT

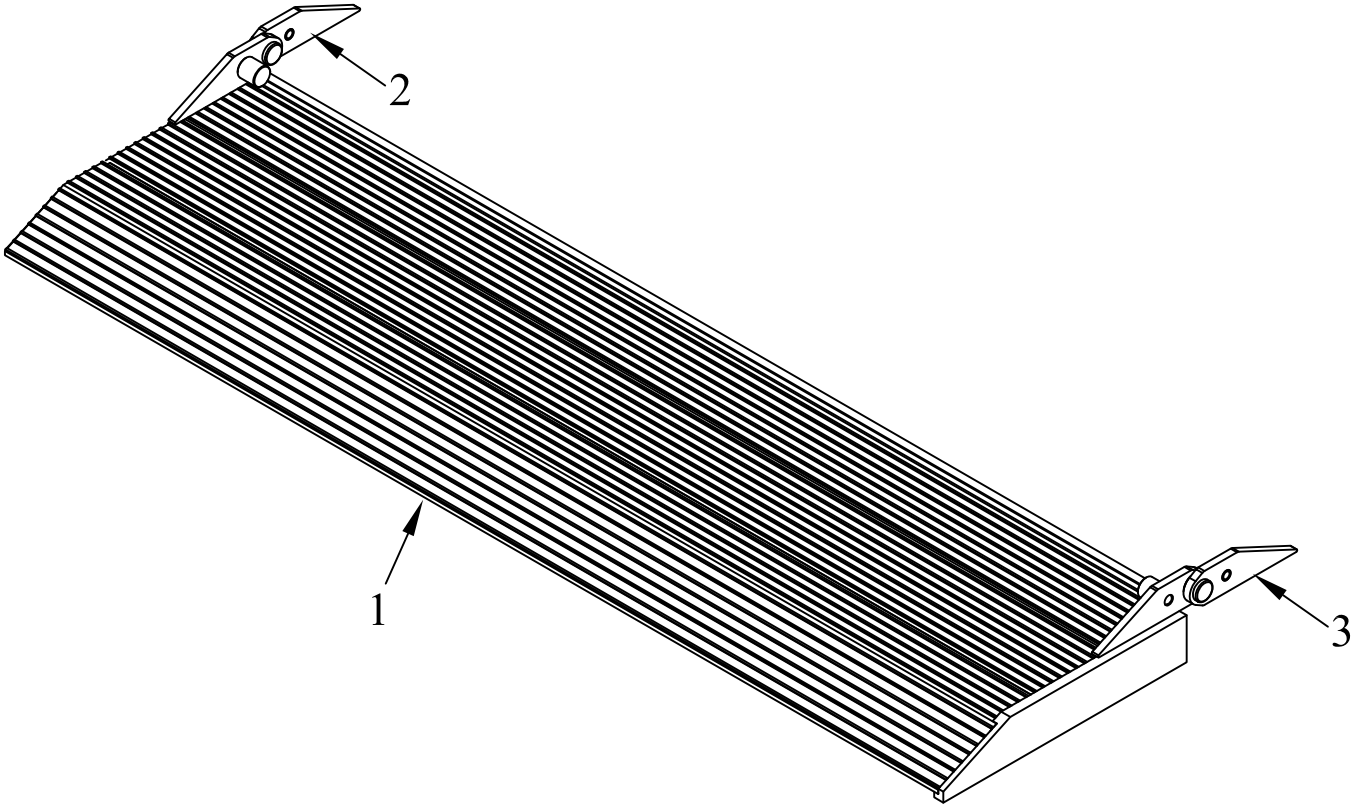

				THIRD ANGLE PROJECTION		FILENAME:		WOODBINE MFG. CO.															
						SYMBOLY PER ANSI Y14.5		BUS BROWN DRIVE															
				<table border="1"> <thead> <tr> <th>DECIMAL</th> <th>2PLC</th> <th>3PLC</th> </tr> </thead> <tbody> <tr> <td>MACHINE SAW, DRILL</td> <td>.030</td> <td>.015</td> </tr> <tr> <td>SHEAR, PUNCH FORM</td> <td>.060</td> <td>.030</td> </tr> <tr> <td>TORCH, WELDING ROUGH CAST</td> <td>.090</td> <td>.060</td> </tr> </tbody> </table>		DECIMAL	2PLC	3PLC	MACHINE SAW, DRILL	.030	.015	SHEAR, PUNCH FORM	.060	.030	TORCH, WELDING ROUGH CAST	.090	.060	DRAWN BY. DJR		NOTES:		WOODBINE, IOWA 51579	
DECIMAL	2PLC	3PLC																					
MACHINE SAW, DRILL	.030	.015																					
SHEAR, PUNCH FORM	.060	.030																					
TORCH, WELDING ROUGH CAST	.090	.060																					
						DRAWN/DATE 3/17/03		712-647-2050															
						APPVD/DATE 8/7/06																	
A	8/7/06	DRAWN IN AUTOCAD		JCB	KGJ	TITLE 60-F11 REPLACEMENT EA FLIPPER		<small>THE INFORMATION HERE IS CONFIDENTIAL AND MUST NOT BE USED IN ANYWAY DETRIMENTAL TO THE INTEREST OF WOODBINE MFG.</small>															
REV.	DATE	CHANGE RECORD		BY	APPVD	ECN	SALES CATEGORY 45	PRODUCT LINE 8002	SCALE N	FIN. WT.	PART NO. 1882												